

EURONICS

+91 8010 930 930 | in@euronics.co.in | www.euronics.co.in

EURONICS INDUSTRIES PRIVATE LIMITED

CORPORATE OFFICE

564-567, Udyog Vihar, Phase V, Sector 19,
Gurugram-122016

MUMBAI

B/003 New India Chamber, MIDC Central Road,
Andheri East, Mumbai, Maharashtra - 400093

HYDERABAD

Plot No. 208, 2nd Floor, Kavuri Hills Phase 2,
Madhapur, Hyderabad-500033

SURAT

Velocity Business Hub, 12th Floor, LP Savani Rd,
Adajan, Surat, Gujarat - 395009

KOLKATA

Office No. 419B, PS QUBE, Street Number 11,
Newtown, Kolkata, West Bengal - 700156

INDORE

DevX, 601, 6th floor, NRK Business Park,
PU 4, B/H Mangal City Mall, Indore - 452010

VISAKHAPATANAM

Kailash Towers, MVP Colony, Sector 1,
Near Amma Hospital, Visakhapatnam-530017

NAGPUR

MBW, Maxx Pride, Manish Nagar,
Beltarodi Road, Nagpur-441108

HUBLI

Prashanth Colony, Shirur Park, Vidya Nagar, Hubli,
Karnataka - 580031

TRIVANDRUM

Dotspace Business Center, TC 24/3088
2nd Floor, Kowdiar Trivandrum - 695003

JAIPUR

RAW Office Space, Plot no. 8, Govind Marg,
Block-B, Malviya Nagar, Jaipur, Rajasthan 302017

RAJKOT

Dev X, 3rd Floor, A wing, Om 9 Square 150 Feet Ring Rd
Circle, Nana Mava, Rajkot, Gujarat 360003

BANGALORE

557, Ground Floor, 9th A Main Road, 1st Stage Rd,
Indiranagar, Bengaluru, Karnataka - 560038

VADODARA

3rd Floor, 313 - 321 Neptune Edge,
Dr. Vikram Sarabhai Marg, Vadodara - 390007

NOIDA

3rd Floor, The Iconic Corenthum Building, Sec-62,
Noida, Uttar Pradesh - 201301

UDAIPUR

DevX, 501 - 510, 5th floor, Plot no. A, Paras Prime
Railway Colony, Udaipur, Rajasthan 313001

RAIPUR

Zenith Co-working Space, 7th Floor, Currency
Tower, Raipur, Chhattisgarh - 492001

PUNE

7060, 7th Floor Marvel Feugo, Magarpatta
Road, Hadapsar, Pune, Maharashtra - 411028

AHMEDABAD

401/402 YASH ANANT Opp Old RBI
Ashram Road AHMEDABAD- 380009

CHENNAI

Plot No:90, 1st Floor, Thirumalai Nagar,
Annexe 3rd Cross Street, Chennai-600096

CHANDIGARH

Space Jam, SCO 50-51, 3rd Floor,
Sector-34 A, Chandigarh - 160034

LUCKNOW

NeoHub, 212, 2nd Floor, Levana Cyber Heights,
Vibhuti Khand, Lucknow - 226010

GOA

J N Chambers, Dr. P. Shirgaonkar Road, Panjim,
Goa - 403001

COIMBATORE

No. 11/4, Pooja Garden, Civil Aerodrome Post,
Kalapatti, Coimbatore - 641014

GUWAHATI

183, Shreeji Tower, 3rd Floor, Christian Basti,
Guwahati - 781005

KOCHI

Hilite Platino Room 204, Shankar Nagar,
Kannadikkadu, Maradu, Kochi-682304

BHOPAL

R WorkSquare Plot No-21, Unit No- EC 11,
Near AajTak News, M.p. Nagar, Bhopal - 462011

PATNA

The Hub, 2nd Floor, Near Regent cinema,
Gandhi Maidan Rd, Patna, Bihar - 800004

KANPUR

Workobar Coworking Space, Floor No. 3-B, 3-C,
3-D, 4/275, Tilak Nagar, Kanpur, 208002 (UP)

BHUBANESWAR

OU-640, 6th Floor, Nexus Esplanade
Cuttack-Rd, Bhubaneswar Odisha - 751010

DEHRADUN

J2.0 Jumpstart Haridwar Bypass Road,
Dehradun, Uttarakhand - 248001

JAMMU

7 SEAS International Education, 539 A,
Gandhi Nagar Jammu J & K - 180004

RANCHI

9th Floor, Mahabir Tower, Opp. of JD
Corporate, Main Road Ranchi-834001

GLOBAL PRESENCE

US | SPAIN | SINGAPORE | MALAYSIA

* EURONICS is a registered trademark

OUR MANUFACTURING FACILITY

Euronics Tech Works Private Limited
Plot 7D, Sarhaul, Sector 18, Gurugram,
Sarhol, Haryana 122015



Mar 2026 | Edition



EURONICS

ELEVATING HYGIENE EVERYDAY



EURONICS ENTREE Industrial & Entrance Management Solution

Experience seamless entry with Euronics Entree, where innovation meets functionality. Designed to enhance safety, efficiency, and aesthetics, our solutions ensure every detail contributes to a lasting first impression.

Built for durability and style, we redefine how businesses manage entrances, setting new standards in excellence and order.





QUICK REFERENCE

SUGGESTIVE SITE APPLICATIONS

-  CORPORATE
-  RETAIL
-  HOTEL
-  RESTAURANT
-  INSTITUTION
-  INDUSTRY
-  HEALTHCARE
-  WELLNESS
-  AIRPORT
-  METRO

INDICATIVE FEATURES

-  HOT & COLD
-  AIR FLOW
-  TEMPERATURE CONTROL
-  VANDAL PROOF
-  COUNTER
-  TOUCH START
-  TOUCH FREE
-  GERM FREE
-  SENSOR

INDEX

WHO WE ARE



05

WHAT WE DO



06

WHAT WE OFFER



07

OUR CLIENTS



08

SUPER SLIM AIR CURTAINS



11

ENTRANCE MATTING SOLUTIONS



18

QUEUE MANAGERS



27

STEEL BOLLARD



32

SHOE COVER DISPENSERS



34

SHOE SHINING MACHINES



36

India's Largest Washroom Automation Manufacturing Facility

31+

Pan India Offices

4+

International Offices

750+

Team Members

5,00,000+

Satisfied Customers



Euronics has acquired a 2-acre, 1.5 lakh square feet area to open **India's Largest Manufacturing Plant for washroom automation accessories** in the heart of Gurugram. Equipped with state-of-the-art Japanese bending and laser-cutting technology, the facility enhances our capabilities in innovation, production, and design. With a talented team of product designers and engineers driving monthly new product development, this expansion reinforces our commitment to delivering premium, best-in-class solutions while seamlessly managing ambitious projects from concept to completion.

WHO WE ARE

You Wish; We Deliver

EURONICS Inspire - your one-stop destination for everything related to public washrooms and hygiene solutions. From cutting-edge washroom automation and stylish bathroom accessories to CP fittings and sanitary ware, we provide comprehensive solutions that transform washrooms into cohesive, functional, and aesthetically pleasing spaces.

Discover the perfect blend of style, functionality, and hygiene with our tailored offerings, designed to meet the unique needs of both large corporations and private individuals. Backed by our in-house manufacturing capabilities, we deliver customized solutions that cater to your specific requirements.

With a legacy of excellence in providing state-of-the-art products, installation equipment, and accessories, EURONICS is committed to transforming washroom facilities across industries. Our solutions are crafted to maintain the highest standards of cleanliness and efficiency while remaining cost-effective and user-friendly.

At EURONICS, we take pride in empowering organizations and individuals with world-class products that reflect impeccable style and integrity. Our commitment to global sustainability initiatives ensures that our practices and products contribute to a greener future.

Experience the EURONICS difference - elevate your washroom facilities with solutions that redefine excellence, hygiene, and sustainability.

WE HAVE DELIVERED MORE THAN ONE MILLION FITTING UNITS

WE ARE PROUD,
WE ARE STILL CONTINUING...



WHAT WE DO

Euronics line of utility products and solutions, boast of it's advanced technology that are designed to deliver cost effectiveness, durability, styling and compliance options across varied price-points.

- # USE MATERIALS THAT ARE PRO GREEN
- # CUT DOWN ON RUNNING EXPENSES
- # HELP REDUCE CARBON FOOT PRINT
- # PROVIDE ADVANCED TECHNOLOGY SOLUTIONS
- # INTERNATIONAL HI-DESIGN QUOTIENT PRODUCTS
- # PROVIDE LONG-TERM VALUE PRODUCTS
- # DURABLE LASTING FUNCTIONALITY PRODUCTS
- # REDUCE RECURRING MAINTENANCE

EURONICS HAS ESTABLISHED STATE-OF-THE-ART IN-HOUSE MANUFACTURING FACILITIES, BACKED BY CONSTANT R&D TO INNOVATE, DEVELOP, AND DELIVER UNIQUE PRODUCTS. OUR COMMITMENT IS TO PROVIDE BEST-IN-CLASS OFFERINGS THAT REFLECT OUR DEDICATION TO EXCELLENCE AND CUSTOMER SATISFACTION.

From our earliest innovations to our latest offerings, our extensive catalog now showcases 750+ meticulously crafted products, thoughtfully organized into three distinct verticals. These verticals are designed for seamless navigation and tailored to meet diverse requirements, making selection effortless and precise.

WHAT WE OFFER

EURONICS INSPIRE



HAND DRYERS
WASHROOM PANELS
SENSOR TAPS
URINAL & WC SENSORS
PAPER & SOAP DISPENSERS
GRAB BAR & ACCESSORIES
BABY DIAPER CHANGING STATIONS
BEHIND MIRROR SERIES
FRAGRANCE DISPENSER

BATH & SANITARYWARE



FAUCETS
SANITARYWARE
DESIGNER CERAMIC
CISTERNS
ALLIED
BATHROOM ACCESSORIES
FLOOR GRATING & DRAINS

EURONICS ENTREE



AIR CURTAINS
ENTRANCE MATTING SOLUTIONS
Q MANAGERS
STEEL BOLLARDS
SHOE COVER DISPENSERS
SHOE SHINING MACHINES

WE MAKE IT EASY TO SPECIFY THESE PRODUCTS THROUGH A SEASONED CUSTOMER SERVICE STAFF AND THE BEST INFORMATIONAL TOOLS IN THE INDUSTRY.



RESIDENTIAL



CINEMAS



HOTELS



CORPORATE & CO-WORKING



HEALTH & WELLNESS CENTRES



HOSPITALS



AIRPORTS



RETAILS



SCHOOL & COLLEGES

OUR CLIENTS OUR PRIDE

OUR PRIVILEGED CLIENTS

Microsoft®

Google™

facebook

PVR

DELHI INDIRA GANDHI INTERNATIONAL AIRPORT

Infosys®

ORACLE®



accenture

IBM

LARSEN & TOUBRO

DLF BUILDING INDIA

Coca-Cola

Nestlé

pepsi.

Having crossed 50,000+ projects EURONICS has already forayed into the washroom automation products & solutions industry. Today it has become a reputed name amongst architects and consultants; for its advanced technology, functional durability, timely delivery and prompt after sales service to it's customers.



AIR CURTAINS ENGINEERED
TO SUPPORT HEALTHY ENVIRONMENTS
AND REDUCE ENERGY CONSUMPTION

visit www.euronics.co.in

SUPER SLIM AIR CURTAINS

At EURONICS entree, our centrifugal Air Curtains are with high international quality standards.

The air curtain maintains environmental separation with a light flow of air, that not only results in lowered energy costs but also helps in preventing air borne contaminants & deterring flying insects from moving from one open space to another-enhancing sanitation & hygiene.

Applications

Entrance of Industries, Restaurants, Offices, Malls & other commercial places



Cooling Retention Effects
Prevents cold air to go outside & hot air to come inside



Super Sleek design
Aesthetics that speaks of Slim design & looks apt for any modern environment



Resists ingress of dirt & insects
The even air flow pressure helps in keeping away insects



Velocity Control feature
Gives full access to control the mode of air curtain depending on door height

EAC
AIR CURTAIN
MS Powder Coated
Upto 11 Feet



DOOR SENSOR



VELOCITY CONTROL SWITCH



COMMERCIAL USE

KEY FEATURES

Model no.	EAC3	EAC4	EAC5	EAC6
Body Material	MS Powder Coated	MS Powder Coated	MS Powder Coated	MS Powder Coated
Dimension (mm)	900 x 230 x 212	1200 x 230 x 212	1500 x 230 x 212	1800 x 230 x 212
Max. Air velocity at Nozzle	21 m/s	21 m/s	21 m/s	21 m/s
Noise Level dB	50 - 70 db	50 - 70 db	50 - 70 db	50 - 70 db
No. of Blowers	3	4	5	6
No. of Motors	2	2	3	3
HP	0.56	0.76	0.95	1.12
Voltage	220V/50Hz	220V/50Hz	220V/50Hz	220V/50Hz
No. of Shafts	1 Single + 1 Double	2 Double	1 Single + 2 Double	3 Double
Power Wattage	410 W	560 W	700 W	820 W
Phase	Single	Single	Single	Single
RPM (Max/ Min)	2700 / 2100	2700 / 2100	2700 / 2100	2700 / 2100
Blower Material	ABS	ABS	ABS	ABS
CFM	825	1100	1380	1490
% insect / dust rejection	75%	75%	75%	75%
Effective Height	Below 11 Feet	Below 11 Feet	Below 11 Feet	Below 11 Feet
Weight Kgs.	19	22	26	32
*Parameters may vary 5-10% depending on various conditions.				
Warranty	1 Year	1 Year	1 Year	1 Year

visit www.euronics.co.in



EAS

AIR CURTAIN
Stainless Steel
Upto 11 Feet



KEY FEATURES

Model no.	EAS3	EAS4	EAS5	EAS6
Max. Air velocity at Nozzle	21 m/s	21 m/s	21 m/s	21 m/s
Power (W)	410 W	560 W	700 W	820 W
RPM (Max/ Min)	2700 / 2100	2700 / 2100	2700 / 2100	2700 / 2100
CFM	825	1100	1380	1490
Body Material	Stainless Steel (304 Grade)	Stainless Steel (304 Grade)	Stainless Steel (304 Grade)	Stainless Steel (304 Grade)
Dimension (mm)	900 x 230 x 212	1200 x 230 x 212	1500 x 230 x 212	1800 x 230 x 212
Noise Level dB	50 - 70 db	50 - 70 db	50 - 70 db	50 - 70 db
No. of Blowers	3	4	5	6
No. of Motors	2	2	3	3
No. of Shafts	1 Single + 1 Double	2 Double	1 Single+2 Double	3 Double
Blower Material	ABS	ABS	ABS	ABS
Phase	Single	Single	Single	Single
Effective height	Below 11 feet	Below 11 feet	Below 11 feet	Below 11 feet
Weight Kgs	19	22	26	32
*Parameters may vary 5 - 10% depending on various conditions.				
Warranty	1 Year	1 Year	1 Year	1 Year

ABE

AIR CURTAIN
ABS Body with Inbuilt Sensor & Remote
Upto 11 Feet



KEY FEATURES

Model no.	ABE3	ABE4	ABE5
Body Material	Plastic	Plastic	Plastic
Dimension (mm)	900 x 230 x 220	1200 x 230 x 220	1500 x 230 x 220
Max. Air velocity at Nozzle	21 m/s	21 m/s	21 m/s
Noise Level dB	47 - 52 db	49 - 54 db	50 - 55 db
No. of Blowers	3	4	5
No. of Motors	2	2	3
HP	0.56	0.76	0.95
Voltage	220V/50Hz	220V/50Hz	220V/50Hz
No. of Shafts	1 Single + 1 Double	2 Double	1 Single + 2 Double
Power Wattage	410 W	560 W	700 W
Phase	Single	Single	Single
RPM (Max/ Min)	2700 / 2100	2700 / 2100	2700 / 2100
Blower Material	ABS	ABS	ABS
CFM	825	1100	1380
% insect/ dust rejection	75%	75%	75%
Effective Height	Below 11 Feet	Below 11 Feet	Below 11 Feet
Weight Kgs.	15	19	25
*Parameters may vary 5 - 10% depending on various conditions.			
Warranty	1 Year	1 Year	1 Year



EIA
INDUSTRIAL AIR CURTAIN
MS Powder Coated
Upto 22 Feet



KEY FEATURES

Model no.	EIA3	EIA4	EIA5
Body Material	MS Powder Coated	MS Powder Coated	MS Powder Coated
Dimension (mm)	914 x 345 x 351	1218x 345 x 351	1523 x 345 x 351
Max. Air velocity at Nozzle	24 m/s	24 m/s	24 m/s
Noise Level dB	<65 db	<66 db	<68 db
No. of Blowers	2	3	4
No. of Motors	1	2	2
HP	1.5	2.24	2.99
Power Wattage	1100 W	1650 W	2200 W
Phase	Three	Three	Three
RPM (Max/ Min)	2700	2700	2700
CFM	2200	2950	3680
Blower Material	Galvanise Steel	Galvanise Steel	Galvanise Steel
Voltage	440v/50hz	440v/50hz	440v/50hz
Effective height	Above 11 Feet	Above 11 Feet	Above 11 Feet
Weight Kgs.	44	51	62
*Parameters may vary 5 - 10% depending on various conditions.			
Warranty	1 Year	1 Year	1 Year

EIS
INDUSTRIAL AIR CURTAIN
Stainless Steel
Upto 22 Feet



KEY FEATURES

Model no.	EIS3	EIS4	EIS5
Body Material	Stainless Steel (304 grade)	Stainless Steel (304 grade)	Stainless Steel (304 grade)
Dimension (mm)	914 x 345 x 351	1218x 345 x 351	1523 x 345 x 351
Max. Air velocity at Nozzle	24 m/s	24 m/s	24 m/s
Noise Level dB	<65 db	<66 db	<68 db
No. of Blowers	2	3	4
No. of Motors	1	2	2
HP	1.5	2.24	2.99
Power Wattage	1100 W	1650 W	2200 W
Phase	Three	Three	Three
RPM (Max/ Min)	2700	2700	2700
CFM	2200	2950	3680
Blower Material	Galvanise Steel	Galvanise Steel	Galvanise Steel
Voltage	440v/50hz	440v/50hz	440v/50hz
Effective height	Above 11 Feet	Above 11 Feet	Above 11 Feet
Weight Kgs.	44	51	62
*Parameters may vary 5 - 10% depending on various conditions.			
Warranty	1 Year	1 Year	1 Year



ENTRANCE MATTING SOLUTIONS

EXCELLENT & DURABLE MATTING SOLUTIONS THAT KEEP SPACES CLEAN & DRY

At EURONICS Entree, we offer a wide range of innovative entrance matting solutions designed to protect floors and carpets from dirt and debris. Combining safety, quality, and durability, our mats come in various colors, shapes, and sizes to suit any decor and traffic level.

Ideal for hotels, offices, industries, malls, and hospitals, Euronics Matting Products are cost-effective and built to perform.



visit www.euronics.co.in

ALUMINIUM DUST BUSTER

5014 ALUMINIUM MATTING

Recessed / Surface

Our Dust - Buster Recessed Aluminium Matting is ideally suited for high traffic areas and also keeps floors clean & dry by providing exceptional wiping/scraping action.

These aluminium profiles are Antirust and can be concealed inside the flooring, which gives an premium look to the entrance area.

COLORS



EXTRA

Side edging for the floor installation

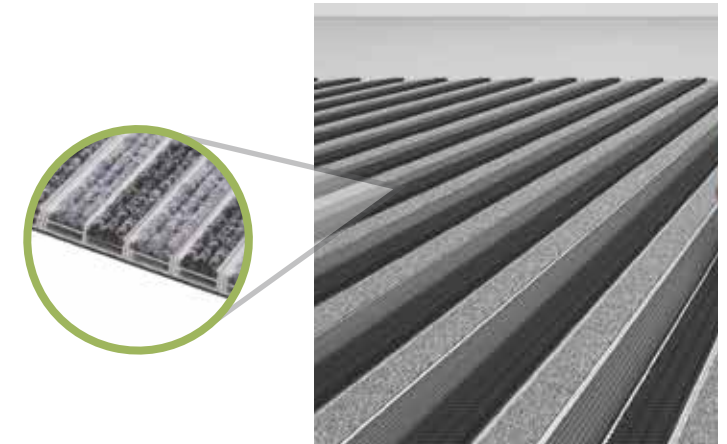

Position of Matting	Inside/Foyer Area
Material	Aluminium Profile with Carpet
Area	High Traffic
Colours	Brown, Grey
Profile Height	14,5 mm
Total Height	19,5 mm
Recess Required	15 mm
Pedestrian Traffic	Upto 10 Lakh (Annually)
Trolley Crossings	Heavy Trolley
Maintenance	Easy to clean
Application	Recessed / Surface
Warranty	5 Years

*Sizes may vary upto ± 0.30 mm



ENIGMA MODULAR MATTING

INTERLOCKING TILES

Surface

ENIGMA MODULAR interlocking tiles is a new generation matting system is designed for extra heavy duty traffic combining attractiveness with performance - dual action of scrapping and absorbing for effective elimination of dirt, dust and moisture. Montreo Carpet inside the tile prevents fine dust particles and moisture from entering inside the door. Each tile is 300 x 300 mm square and 18mm depth. The large open scraper profiles incorporate 'heel steps' to prevent heel trapping.

Application: Main porch area of 5 Start Hotels / Office / Malls.



COLORS



GREY

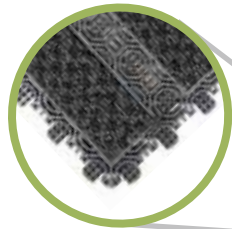

Position of Matting	Main Porch Entrance Area
Material	EVA frame with Carpet
Area	High Traffic
Colours	4025G, Grey
Tile Height	18 mm
Tile Size	300 mm x 300 mm
Connection	Interlocking
Pedestrian Traffic	Upto 10 Lakh (Annually)
Trolley Crossings	Heavy Trolley
Maintenance	Easy to clean
Application	Surface/Recessed
Warranty	3 Years

visit www.euronics.co.in



MONTERO CARPET MATTING

ABSORBS MOISTURE & DIRT

Surface

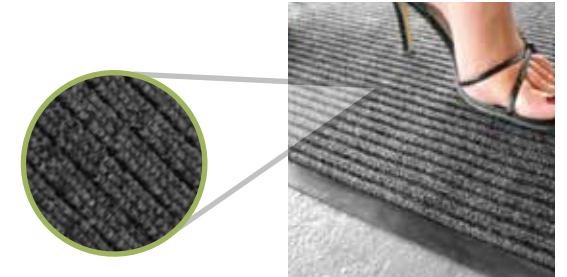
Montreo Carpet Matting: Absorbs Moisture & Dirt. It is carpet-type entrance matting. Provides excellent dirt and water removal. Holds dirt and moisture off the floor. Durable and stain resistant. Vinyl backing won't stain the floor and helps prevent dirt and moisture from penetrating through the mat to the floor.



Model No.	Montreo 3015	Montreo 3012	Montreo 3006
Position of Matting	Inside / Foyer	Inside / Foyer	Inside / Foyer
Material	Nylon with Fibre	Nylon/ Polyprop	Nylon/ Polyprop with fiber
Area	High Traffic	Medium Traffic	Low Traffic
Available Colours	Grey	Grey, Brown	Grey, Brown
Shape	Carpet	Carpet	Ribbed Carpet
Backing	Hard Rubber	Hard Rubber	Rubber
Tear	Not Possible	Not Possible	Not Possible
Pedestrian Traffic	10 Lakh (Annually)	8 lakhs (Annually)	2 lakh (Annually)
Trolley Crossing	Heavy Trolley	Heavy Trolley	Light Trolley
Width	4 & 5 Feet	4 & 5 Feet	4 feet
Maintenance	Easy to Clean	Easy to Clean	Easy to Clean
Colors	 DARK GREY	 DARK GREY	 BROWN

TRAPPER LOOP MATTING

TRAPS, HOLD & HIDES DIRT

Recessed / Surface

Trapper Matting Traps, Hold & Hides Dirt is a vinyl looped construction – An ideal mat for front entrances/exit areas. The unique 'loop' pattern gives it excellent properties for the retention of dirt, dust, debris, fluids from dirty feet, footwear and also allows for easy cleaning when soiled.

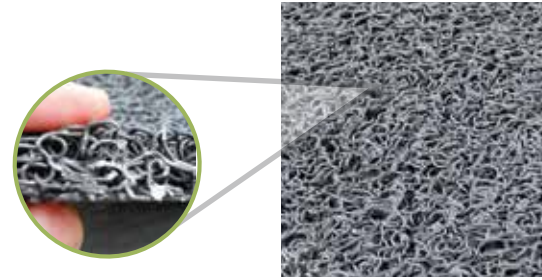

Model No.	Trapper 1018	Trapper 1016	Trapper 1013
Position of Matting	Outdoors or Recessed Area	Outdoor or Recessed Area	Outdoor or Recessed Area
Material	PVC Vinyl	PVC Vinyl	PVC Vinyl
Area	High Traffic	Medium Traffic	Low Traffic
Available Colours	Grey	Grey	Grey
Shape	Loop	Loop	Loop
Backing	Hard	Hard	Soft
Tear	Difficult	Difficult	Easy
Pedestrian Traffic	4 Lakhs Annually	4 lakhs Annually	1 lakhs Annually
Trolley Crossing	Light Trolley	Light Trolley	Trolley Not Advisable
Width	4 Feet	4 feet	4 feet
Maintenance	Easy to Clean	Easy to Clean	Easy to Clean
Colors	 GREY	 GREY	 GREY

X-LERATOR ZIGZAG MATTING

REMOVES DIRT & DEBRIS

Recessed / Surface

X-Lerator Matting : X Web with sharp edges designed to remove heavy amount of dirt. It is a vinyl X web unpacked construction – An ideal mat for front entrances/exit areas and excellent for foyers and recessed wells. The unique X web pattern scrape dirt and moisture from shoes to minimize slips and fall accidents.

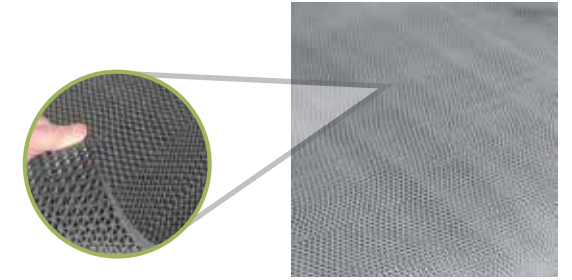

Model No.	X-Lerator 2011	X-Lerator 2085	X-Lerator 2050
Position of Matting	Outdoors or Wet Area	Outdoor or Wet Area	Outdoor or Wet Area
Material	PVC Vinyl	PVC Vinyl	PVC Vinyl
Area	High Traffic	Medium Traffic	Low Traffic
Available Colours	Grey	Grey	Grey
Shape	X-Web	X - Web	X - Web
Backing	Unbacked	Unbacked	Unbacked
Tear	Impossible	Difficult	Easy
Pedestrian Traffic	8 Lakhs Annually	4 lakhs Annually	1 lakh Annually
Trolley Crossing	Heavy Trolley	Light Trolley	Trolley Not Advisable
Width	4 Feet	4 feet	4 feet
Maintenance	Easy to Clean	Easy to Clean	Easy to Clean
Color	 GREY	 GREY	 GREY

Insert for
Aluminium Mat 2024

EURONICS



Code: 1G - Grey Straight Ribbed



Code: 2B - Brown Straight Ribbed



Code: 5G - Grey Stripe Carpet



Code: 8R - Black Ribbed Rubber Profile



Code: 7B - Black Brush Profile

QUEUE MANAGERS

SMOOTHER QUEUES, BETTER EXPERIENCES

Smart products from EURONICS entree, presents Queue Manager systems used for many different purposes including crowd control & waiting lines, that gives a fast and easy, professional look with a dash of utility & performance.

Applications: Bank, Airport, Railways, Malls, Cinemas

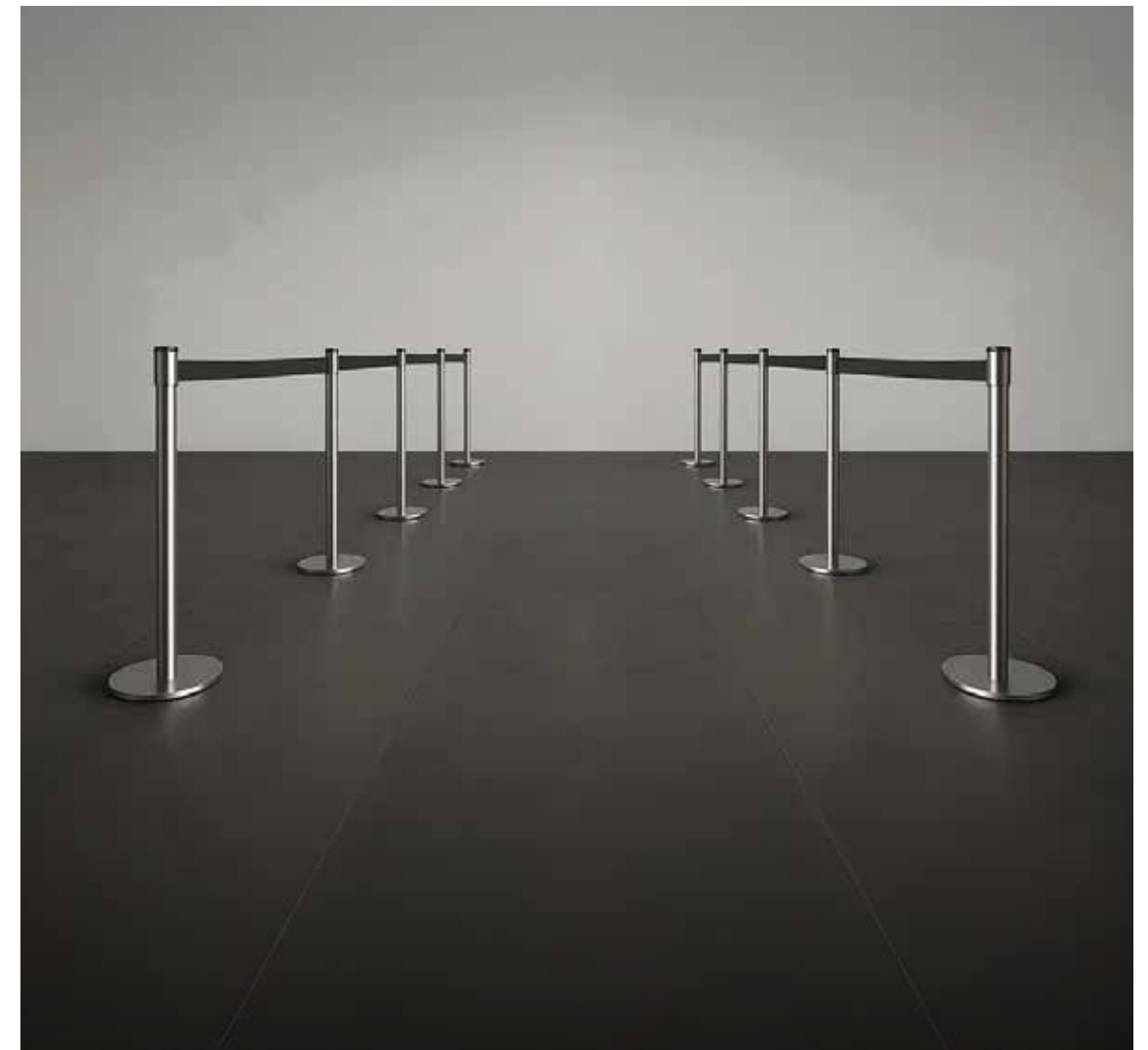

XQM6L

RETRACTABLE BELT STANCHIONS

Stainless Steel

Material	304 Grade stainless steel
Height of Pole	1130 mm
Diameter of Base	350 mm
Weight	9.5kgs
Belt Length	2 Meters
Belt Color	Blue/Black/Red



ZQM1L

RETRACTABLE BELT STANCHIONS

Stainless Steel

Material	202 Grade stainless steel
Height of Pole	1130 mm
Diameter of Base	330 mm
Weight	9.5kgs
Belt Length	2 Meters
Belt Color	Blue/Black/Red

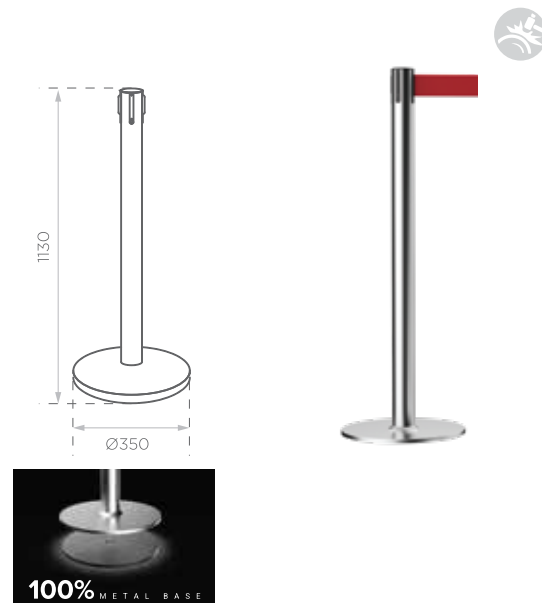

SQM5

STACKABLE

QUEUE MANAGER

Height of Pole	880 mm
Diameter of Base	350 mm
Weight	9.5kgs
Belt Length	2 Meters
Belt Color	Blue/Black/Red

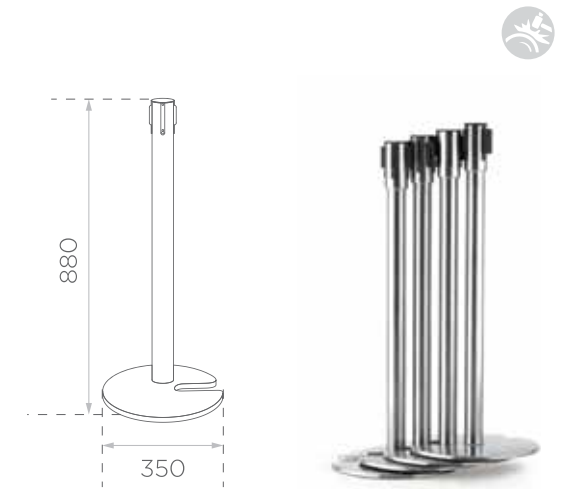

EQM4D

DOUBLE CASSETTES

Stainless Steel

Material	Stainless Steel
Height of Pole	1130 mm
Diameter of Base	350 mm
Weight	9.5 kgs
Belt Length	2 Meters
Belt Color	Blue/Black/Red

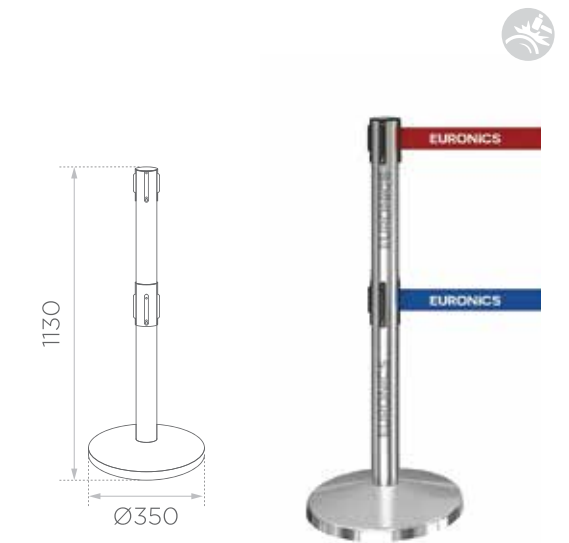

EQM6

WALL MOUNTING Q MANAGER

Stainless Steel

Belt length	2 Meters
Rope Colour	Blue/Black/Red



EQM2P

CLASSIC POST WITH ROPE BARRIER

Stainless Steel

Height of Pole	1000 mm
Diameter of Base	350 mm
Weight	9.5 kgs
Rope Length	1.5 Meters
Rope Colour	Blue/Black/Red

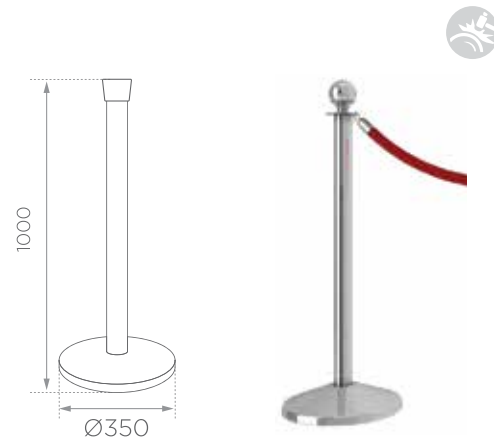

EQM3G

GOLD CLASSIC

POST WITH ROPE BARRIER

Height of Pole	1000 mm
Diameter of Base	350 mm
Weight	7.5 kgs
Rope Length	1.5 Meters
Rope Colour	Blue/Black/Red

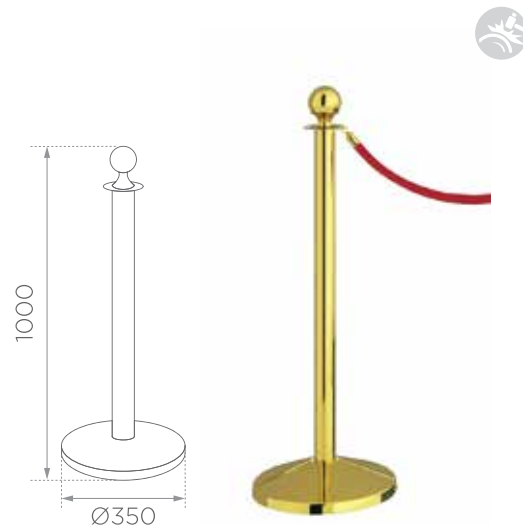

EQM8





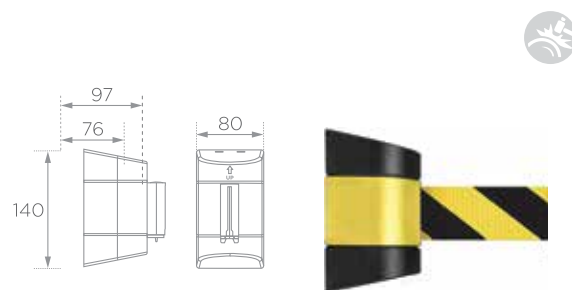

WALL MOUNTING Q MANAGER

Stainless Steel







Belt length	3 Meters
Rope Colour	Black & Yellow



Rope For Queue Manager - Gold

 RVGH Red Rope, Velvet Rope Golden Hook	 LVGH Blue Rope, Velvet Rope Golden Hook	 BVGH Black Rope, Velvet Rope Golden Hook
 RTGH Red Rope, Twisted Thread Golden Hook	 LTGH Blue Rope, Twisted Thread Golden Hook	 BTGH Black Rope, Twisted Thread Golden Hook

Rope For Queue Manager - Silver

 RVSH Red Rope, Velvet Rope Silver Hook	 LVSH Blue Rope, Velvet Rope Silver Hook	 BVSH Black Rope, Velvet Rope Silver Hook
 RTSH Red Rope, Twisted Thread Silver Hook	 LTSH Blue Rope, Twisted Thread Silver Hook	 BTSH Black Rope, Twisted Thread Silver Hook

STEEL BOLLARDS

PERFECT BLEND OF UTILITY & PERFORMANCE

Euronics Steel Bollards are used to form an architectural barricading. Bollards act as visual guide, guide traffic & mark boundaries. Steel Bollards can also be constructed to block vehicle entry, protecting people & building. Our bollards are made of high quality stainless steel, giving impeccable appearance & life.



visit www.euronics.co.in

SSB02S FIXED BOLLARD SURFACE MOUNT

Material	Stainless Steel 304 Grade
Height of Pole	900 mm
Diameter of Pole	102 mm
Thickness Of Pole Sheet	2 mm

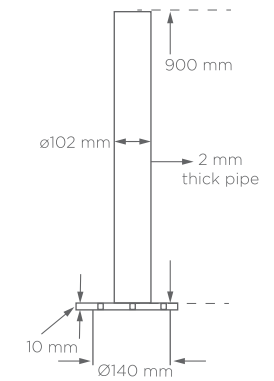

SSB04T FIXED BOLLARD SURFACE MOUNT

Material	Stainless Steel 304 Grade
Height of Pole	900 mm
Diameter of Pole	102 mm
Thickness Of Pole Sheet	2 mm

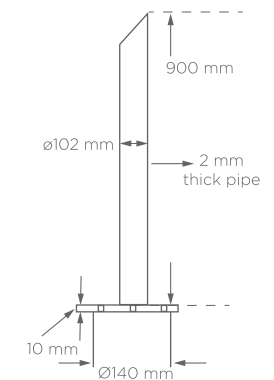

SHOE COVER DISPENSER

SLIP ON, STEP IN, STAY CLEAN

EURONICS entree has been successfully offering durable and high finish Shoe Cover Dispensers, that help protect your floors, prevent contamination and maintains a clean, professional & hygienic environment.

Built sturdy, practical, cost-effective and convenient designed makes it the preferred choice. Perfect Applications for Sample Flats, Hospitals, Clinics, Hotels, Pharmaceutical Companies, Factories, Kitchen and office premises etc.



ESCD1

SHOE COVER DISPENSING MACHINE

Automatic

Compatible Shoe Cover

Code: C1N, Non - Woven Shoe Covers

Code: C1P, Plastic Shoe Covers

Operation	Fully Automatic
Voltage	220V / 50Hz
Rated Power	20W
Automatic	Shoe Counting Function
Loading Capacity	50 Covers (Non-woven)
Loading Capacity	80 Covers (Plastic)
Dimension	750 x 300 x 630 mm



ESCD2

SHOE COVER DISPENSING MACHINE

Semi-Automatic

Compatible Shoe Cover

Code: C2P, Plastic Shoe Covers

Operation	Manual
Material	Aluminium
Loading Capacity	100 Plastic Covers
Dimension	470 x 260 x 170 mm



SHOE SHINING

LET'S STEP OUT WITH A SHINE

The elegant shoe shine machine from EURONICS Entree is a high quality care product for your footwear. Crafted from high quality materials and boasting a sleek design, our premium shoe shine machine will give you gleaming shoes in seconds.

With its stylish shape and modest dimension this model is the perfect shoe care item for a hotels or offices



visit www.euronics.co.in

KSM5 AUTOMATIC SHOE SHINING MACHINE



Operation	Fully Automatic
Material	Stainless Steel/Satin Finish
Voltage	220V / 50Hz
Rated Power	40 W
RPM	1400
Time Protection	15 sec
Container capacity	200 ML
Dimension	370 x 370 x 445 mm



ESM4 SHOE SHINING MACHINE (With Solecleaner)



Operation	Fully Automatic
Material	Stainless Steel/Wooden
Voltage	220V / 50Hz
Rated Power	40 W
RPM	1400
Time Protection	15 sec
Container capacity	200 ML
Dimension	510 x 320 x 495 mm



ESM3 SHOE SHINING MACHINE



Operation	Fully Automatic
Material	Stainless Steel/Wooden
Voltage	220V / 50Hz
Rated Power	40 W
RPM	1400
Time Protection	15 sec
Container capacity	200 ML
Dimension	280 x 370 x 210 mm

